

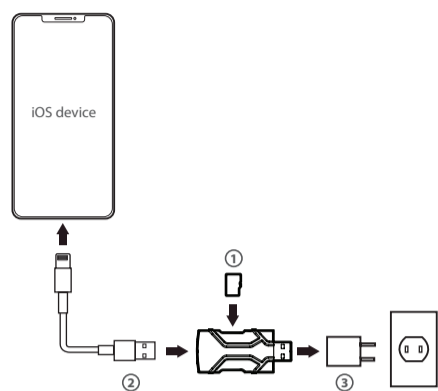

InfinitiKloud

How To Use?

InfinitiKloud Charge is compatible with PC, Mac, Android and iOS devices. It can be used in the below scenario:



For mobile devices, a download of IK in the App Store or Google Play is required.

Connecting to iOS Device

Required hardware/accessories (not included)

- ① MicroSD Memory Card*
- ② MFI approved Lightning Cable**
- ③ Power Adaptor***

* Class 10 or above read/write speed
 ** MFI approved cable equipped USB-A (M) end at USB 2.0 speed
 ***Power adaptor equipped with USB-A (F) port

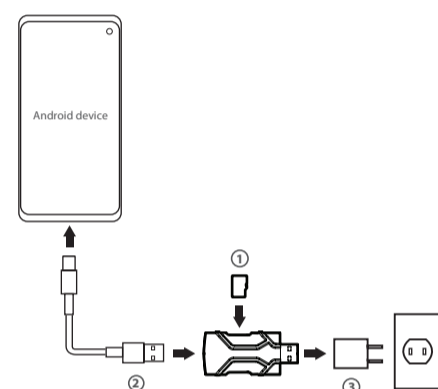

Connecting to Android Device

Required hardware/accessories (not included)

- ① MicroSD Memory Card*
- ② USB-C or Micro USB Cable**
- ③ Power Adaptor***

* Class 10 or above read/write speed
 ** Cable with USB-A (M) end at USB 2.0 speed
 ***Power adaptor equipped with USB-A (F) port

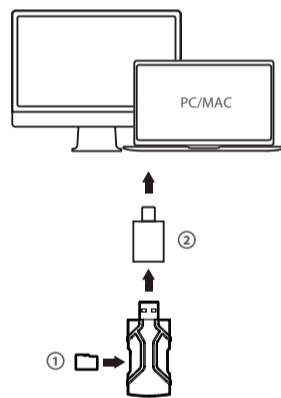

Connecting to PC/Mac

Required hardware/accessories (not included)

- ① MicroSD Memory Card*
- ② Optional USB-C Dongle**

* Class 10 or above read/write speed
 ** Optional for USB-C only desktop/laptop USB-A (F) to USB-C (M) at USB 2.0 speed

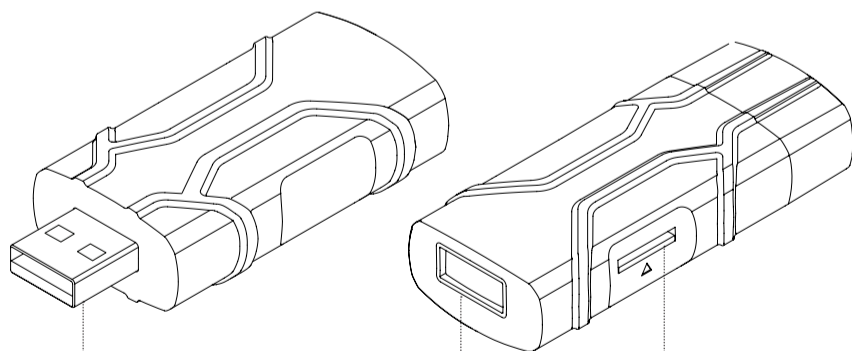

USB-A Connector

USB-A Port

Micro SD Card Slot

IMPORTANT SAFETY INFORMATION

Caution: Do not use device if there is obvious damage.

Warning: Choking hazard. This device is not a toy. Keep away from children.

Important Instructions Before Use

1. Device should only be used for the intended purpose as outlined in the instructions.
2. Do not expose device to moisture or extreme heat.
3. Do not submerge device underwater. Do not expose to liquid, smoke, or steam.
4. Put cap back on USB when not in use to avoid damage.

General Backup

To perform a backup, simply press the red "Start" button on the "General" tab. This may take a couple of minutes, depending on the amount of and the size of your files.

The following file extensions can be backed up:

- Photos/Images: jpeg, jpg, bmp, gif, png, ico, icns, svg, wmf
- Music: mp3, ogg, wma, wav, flac
- Videos: mp4, mpeg, mov, wmv, avi
- Documents: txt, pages, doc, docx, rtf, odt, wpd, pdf, xls, xlsx, xlr, numbers, ppt, pptx, pps, psd

Default backup extensions can be updated on the Custom screen. Once it's updated, default extensions will be changed accordingly. The units are Megabytes and Gigabytes.

The menu will then display your file's statistics and how much space each file is taking up, as well as the amount of free storage space remaining.

Custom Backup

File Types

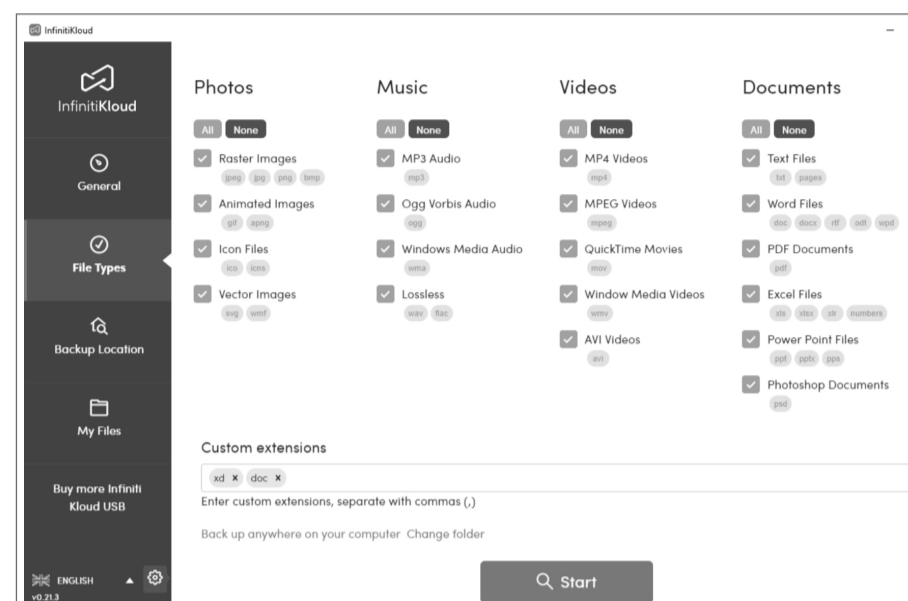

If you wish to back up specific file types, select "File Types". There will be a list of file formats from which you can select to back up.

There are boxes beside the file formats, either with or without a checkmark. The checkmark indicates that the file format is selected to be backed up. If you wish not to back up that format, ensure that it does not have a tick next to it. Click on the boxes to either check or uncheck them.

Once selected, press the red "Start" button to begin backing up those files.

Backup Location

You can also specify the file locations from which you want to back up your files.

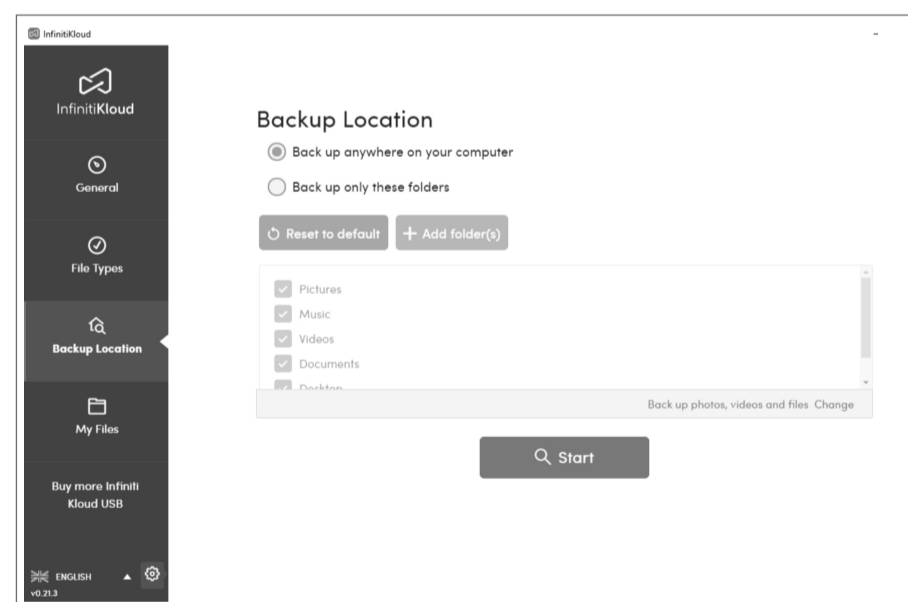

By selecting 'Backup only these folders', you can add specific paths to perform backups.

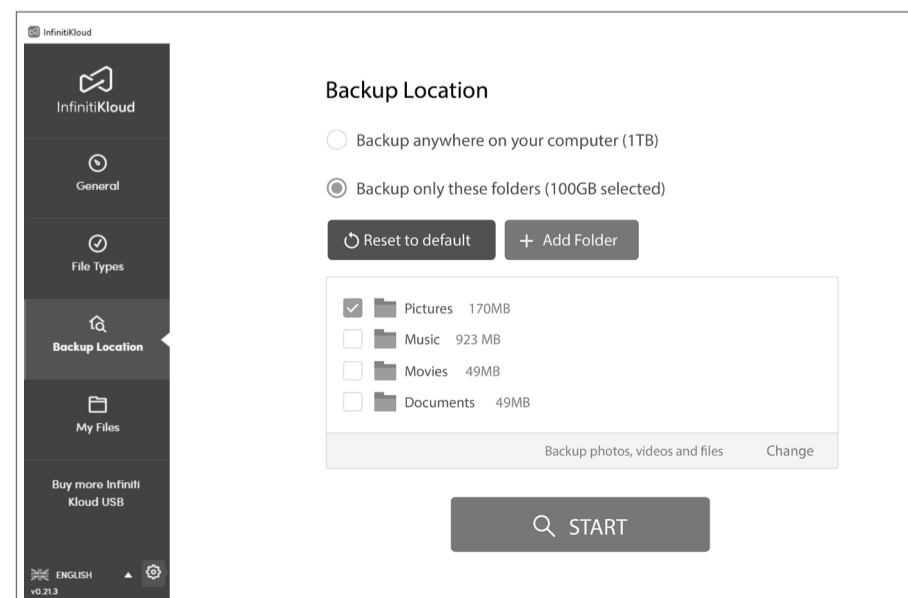

You can also combine custom backups of File Types and Backup Location.

InfinitiKloud User Guide

To begin using the InfinitiKloud Charge, simply plug into your device. The InfinitiKloud will appear in your folders. Open your folders (“File Explorer” for PC, and “Finder” for Mac), and click on the InfinitiKloud icon to start up the program.

Below is what the program should look like. There are tabs on the left indicating each functionality of the InfinitiKloud. Clicking on each tab will enable you to use those functionalities.

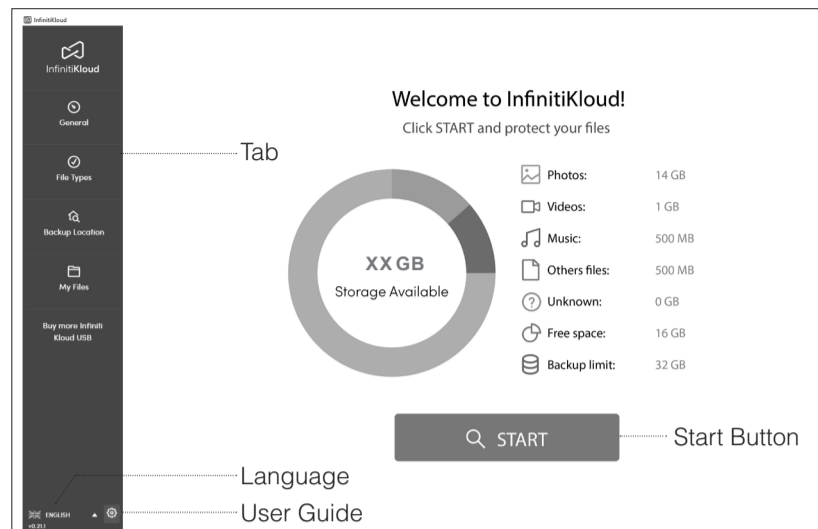

To change the language, hover over the drop-down menu in the bottom left corner of any screen and select your desired language. InfinitiKloud is available in English, German, French, Portuguese.

My Files

To view your backed-up files, go to the tab labeled “My Files”. They will appear in the same folders and formats as they are on your computer. You may look through your folders manually or also use the search tool to find specific files. From there, you can view, export, and delete files. Keep in mind that deleting a file from the InfinitiKloud will not delete the file from your computer. You can back up your data as much as you want. If the backed-up file has been updated, the InfinitiKloud will back up the latest version but still keep the previous one(s).

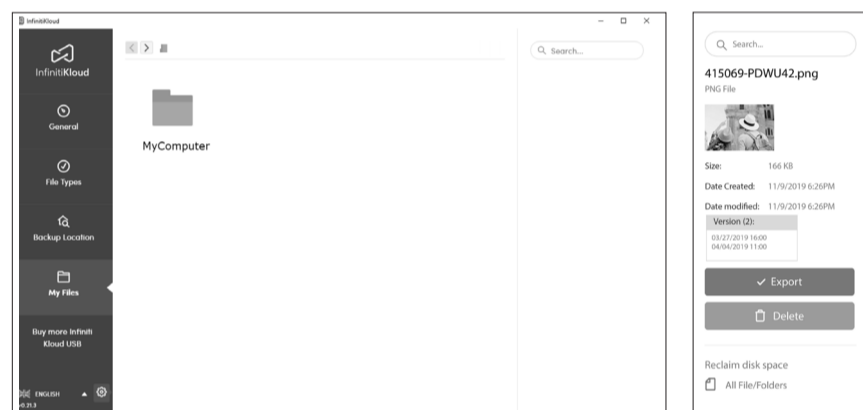

Data Cleanup

This is where you can decide how the data is cleaned up. Click on the gear icon on the bottom left corner. Select “User data”.



Clean Up Your Data

This will erase all backed up data of InfinitiKloud including your pictures, music, videos, documents, and other backed up files.

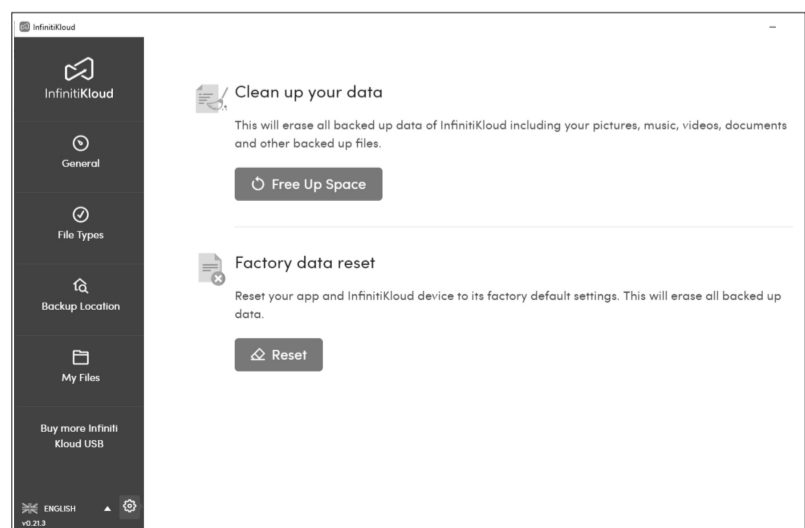

Passcode Settings

To better protect the data that you have backed up, there is a passcode setting that allows you to create your own passcode. The private passcode must include 4 - 6 digits. You will be asked for this passcode when InfinitiKloud is launched. Below are detailed instructions for use of this security feature.

Passcode is enabled across supported platforms: Windows, Android, macOS and iOS.

Enable Passcode

Click on the gear icon on the bottom left corner. Select “Passcode settings”.

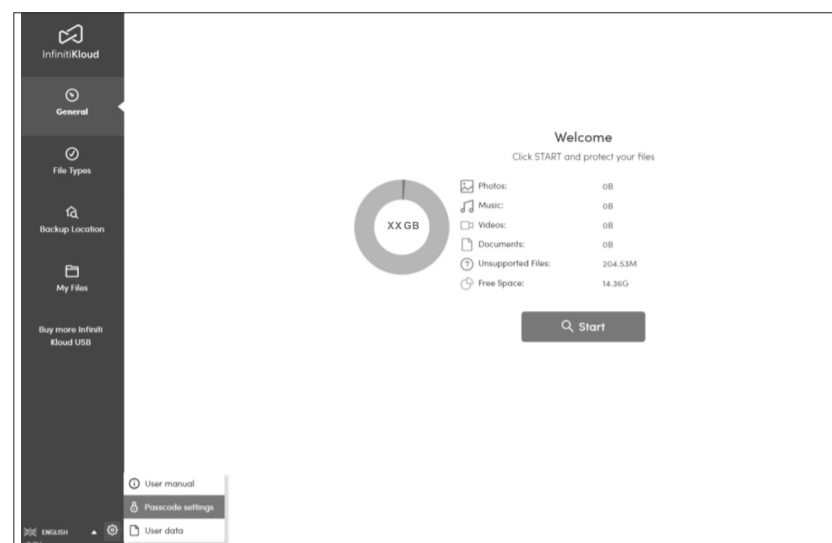

Toggle the “Turn on Passcode” switch to the right to activate.

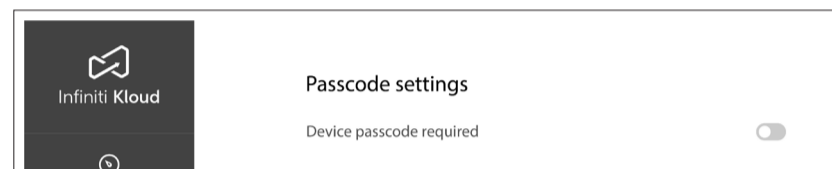

If you wish to remove passcode security, go to Passcode settings. Toggle the “Device passcode required” switch to the left to deactivate.

The passcode will no longer be required to access the InfinitiKloud app.

Set a Passcode

Enter your chosen passcode. It should be 4 to 6 digits long. Click “OK” when complete.

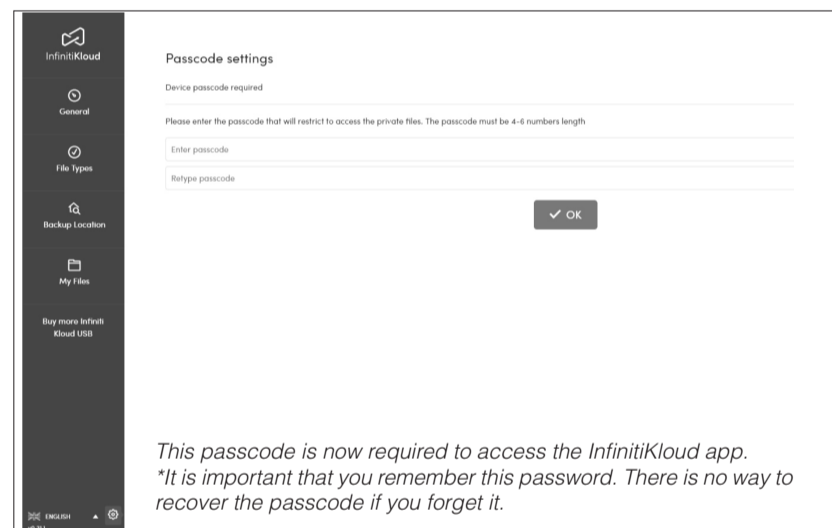

Change or Disable Passcode

Go to Passcode settings, enter the current passcode and new passcode of your choosing and click “Change Passcode”.

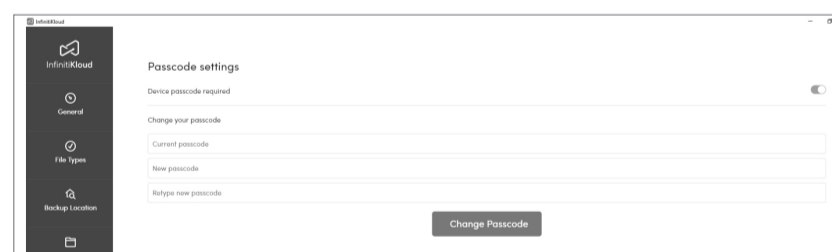

InfinitiKloud Android or iOS App

Use our Google Play or App Store mobile app to back up your mobile devices with one tap. There are 2 ways to download the app:

1. On your Android device or Mac, open Google Play or App Store and search “Infiniti Kloud”. Then Download the app.
2. Download from this link:
<https://play.google.com/store/apps/details?id=com.infinitikloudmobile>



For Android



For iOS

Technical Specifications

USB type	USB 2.0, USB-A port
Read/write speed	Class 10 or above
Size	64 x 28 x 14.8mm (without cap) 66 x 28 x 14.8mm (with cap)

CE The device complies with the European Directives 2014/30/EU.

At the end of its service life, this product may not be disposed of in the normal household waste, but rather must be disposed of at a collection point for recycling electrical and electronic devices. The materials are recyclable according to their labelling. You make an important contribution to protecting our environment by reusing, recycling, or utilizing old devices in other ways. Please ask the municipal administration where the appropriate disposal facility is located.
Subject to change.